



JCB WHEELED EXCAVATOR | JS175W



MAX. OPERATING WEIGHT

17970kg

NETT ENGINE POWER

102kW (138hp)

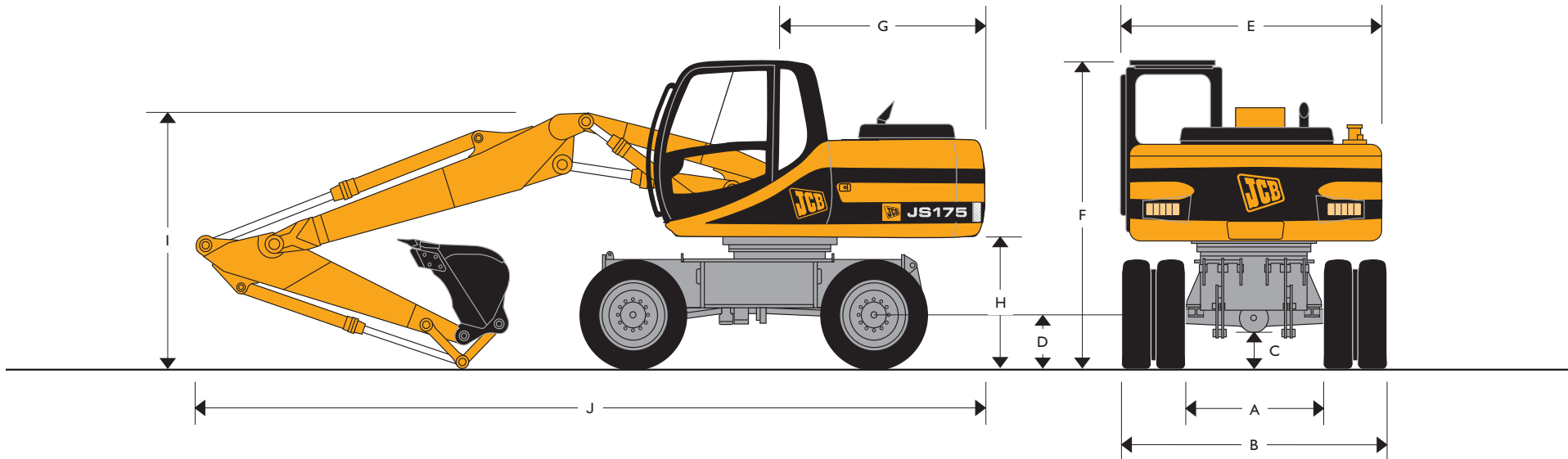

STATIC DIMENSIONS

Dimensions in millimetres (ft-in)	
A	Internal width between dual wheels 1330 (4-4)
B	External width between dual wheels 2490 (8-2)
C	Ground clearance 350 (1-1)
D	Height to axle centre line dual wheels 498 (1-7)
	Height to axle centre line single wheels 519 (1-8)
E	Overall width (handrail removed) 2500 (8-2)
F	Height over cab 3070 (10-0)
G	Tail length 2190 (7-4)
H	Clearance under counterweight 1270 (4-2)

Monoboom

Dipper length		2.25m	2.70m	3.05m
I	mm (ft-in)	2765 (9-1)	2765 (9-1)	3240 (10-7)
J	mm (ft-in)	8145 (26-8)	8135 (26-7)	8306 (27-3)

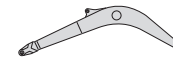

Triple articulated boom

Dipper length		2.25m	2.70m	3.05m
I	mm (ft-in)	2806 (9-2)	2874 (9-5)	3136 (10-3)
J	mm (ft-in)	8123 (26-7)	8118 (26-7)	8083 (26-6)





JCB WHEELED EXCAVATOR | JS175W



CHASSIS OPTIONS

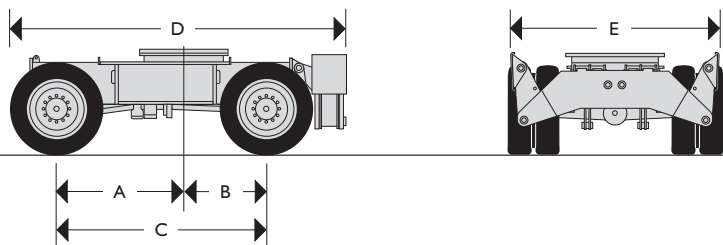

Dimensions in millimetres (ft-in)

A	Centre of slew ring to front axle	1500 (4-11)
B	Centre of slew ring to rear axle	1000 (3-3)
C	Wheelbase	2500 (8-2)
D	Length including rear stabilizers	3950 (12-11)
E	Width over stabilizers (raised)	2480 (8-1)

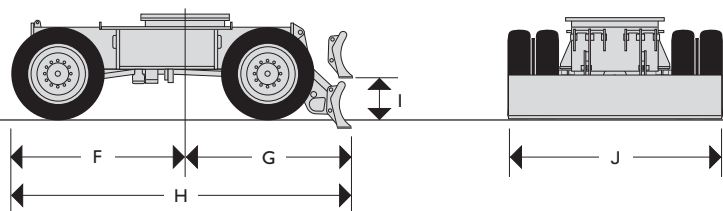

Dimensions in millimetres (ft-in)

F	Centre of slew ring to face of front tyre	1990 (6-6)
G	Centre of slew ring to rear dozer blade (lowered)	2090 (6-10)
H	Length including rear dozer blade (raised)	4050 (13-3)
I	Ground level to bottom of rear dozer blade (raised)	450 (1-6)
J	Dozer blade width	2480 (8-1)

CHASSIS OPTIONS

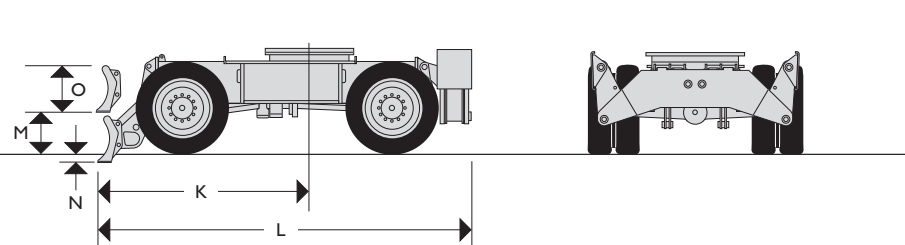

Dimensions in millimetres (ft-in)

K	Centre of slew ring to front dozer blade (lowered)	2530 (8-3)
L	Length including stabilizers and dozer blade (raised)	4460 (14-7)
M	Ground level to bottom of front dozer blade (raised)	450 (1-6)
N	Dozer blade dig depth	130 (0-5)
O	Dozer blade height	500 (1-8)

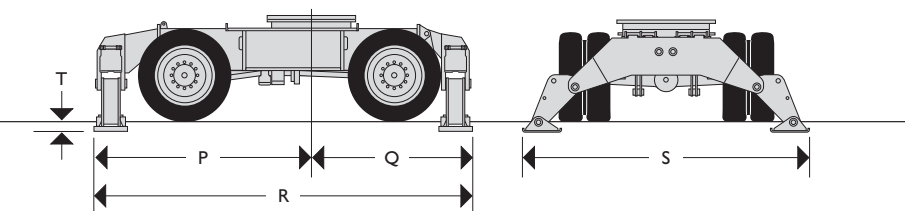

Dimensions in millimetres (ft-in)

P	Centre of slew ring to front stabilizers	2520 (8-3)
Q	Centre of slew ring to rear stabilizers	1960 (6-5)
R	Length including front and rear stabilizers	4480 (14-8)
S	Width over stabilizers (lowered)	3550 (11-8)
T	Stabilizer lift height	130 (0-5)



JCB WHEELED EXCAVATOR | JS175W



ENGINE

Type	Water cooled, 4-stroke, 6-cylinder in-line, direct injection, turbocharged diesel. Stage II emissions compliant.
Net Power	(SAE J1349 and 80/1269/EC) 102kW (138hp) at 1950 RPM.
Piston displacement	6.494 litres
Starting system	24 volt.
Batteries	2 x 12 volt Heavy Duty.
Alternator	24 volt 40 amp.

SWING SYSTEM

Drive train	Axial piston motor and planetary reduction final drive.
Swing brake	Hydraulic braking plus automatic spring applied disc type parking brake.
Swing speed	11.3RPM
Swing gear	Large diameter, internally toothed fully sealed grease bath lubricated.
Swing lock	Multi position switchable brake and mechanical lock.

CHASSIS

Structure	High strength flanged 'u' section.
Chassis Options:	
Dozer Blade	Front or rear pin mount.
Stabilisers	Front or rear pin mount, independently operable – plus combinations.
Grab Stowage	Heavy duty, pin mounted stowage bar.
Transmission	Hydrostatic drive via piston motor and powershift transmission.
Travel speed	Low ratio 14kph (9mph) High ratio 30kph (19mph) Creep speed 3.8kph (2.4mph)
Axles	Four wheel drive. Front steering axle oscillates for rough ground mobility.
Axle load capacity	32 tonnes
Axle oscillation	+/- 8.5 degrees
Ground clearance	350mm (1ft 2in)
Steering	Fully hydraulic system.
Turning radius	To outside of tyres 5.45m (17ft 10in) To outer edge of front mounted dozer blade 6.06m (19ft 10in)
Brakes	All hydraulic, dual circuit brake system.
Parking Brake	Built into the transmission.

EXCAVATOR END

Booms	Monoboom or triple articulation boom with choice of dipper lengths to match the requirements of reach, lift capacity and tearout.
Bucket tipping links	Fabricated type with choice of 1 tonne lift, max capacity lift and no-lift point – with link stowage lock (grab work).

MAIN HYDRAULIC SYSTEM

System	Load-sensed hydraulic system with twin variable flow piston pumps providing flow-on-demand for maximum efficiency.
Main pumps	2 variable displacement axial piston type.
Maximum flow	2 x 156l/min (34 UK gpm)
Main circuit pressure	314 bar (4555 lb/in ²)
With power boost	343 bar (4975 lb/in ²)
Servo pump	Gear type
Maximum flow	27 l/min (6 UK gpm)
Servo pressure	40 bar (580 lb/in ²)
Optional Circuits:	
Hammer	Includes automatic engine speed setting and return filter.
Maximum flow	138 l/min (30 UK gpm)
Maximum pressure	314 (343) bar (4555/4975 lb/in ²) (pre-set to 180 bar (2610 lb/in ²))
Grab operation	
Maximum flow	138 l/min (30 UK gpm)
Maximum pressure for grab ram operation	314 (343) bar (4555/4975 lb/in ²)
Low Flow Pipework	Two options available, one with 20L/min (4 UK gpm) flow and a second with an adjustable flow of 27-45L/min (6-10 UK gpm).
Hydraulic Cylinders	With hardened, chromed piston rods and end cushioning on boom, dipper and bucket crowd cylinder.
Filtration	
In tank	150 micron, suction strainer.
Main return line	10 micron, fibreform element.
Pilot line	10 micron, paper element.
Plexus by pass line	1.5 micron paper element.
Hydraulic hammer return	10 micron, reinforced microform element.

TYRES

Twins	10.00 x 20 tyres (16PR) with spacer ring.
Singles	18R x 19.5 tyres (Radials).

CAB

Press steel with high strength rolled section frame. All tinted safety glass windows with fully opening two piece windscreen and in screen stowage. Gas strut assisted. Parallelogram wash/wiper. Opening door windows. Fan force fresh air ventilation and heater with windscreen demister.

Fully adjustable deluxe suspension seat with armrest and backrest recline. Radio cassette player with digital tuning. Cigarette lighter. Digital clock and storage box are standard fitment.



JCB WHEELED EXCAVATOR | JS175W



INSTRUMENTATION

AMS – Advanced Management System

The JCB Advanced Management System matches engine power and pump output to optimise machine performance in each of the four selectable work modes –

H (Heavy)	100% engine and hydraulic power for maximum output.
S (Standard)	90% engine and hydraulic power for good economical output.
L (Light)	70% engine and hydraulic power for precision finishing and low fuel consumption.
F (Fine)	70% power with permanent power boost for maximum lifting ability.

The system monitors all critical machine functions and operator selections which are shown on the display panel, conveniently mounted in the operators line of site. The diagnostic function built into the system constantly monitors machine usage and performance, as well as providing the service engineer with valuable information on any machine fault.

STANDARD EXCAVATING BUCKETS

All buckets are JCB – Esco fully welded steel, with sealed, hardened steel pivot pins and replaceable wear parts.

Max Width mm (in.)	Capacity (SAE heaped) cu.m (cu.yd)	Weight kg (lb)
600 (24)	0.35 (0.46)	426 (937)
750 (30)	0.49 (0.64)	480 (1056)
900 (36)	0.62 (0.81)	525 (1155)
1000 (40)	0.72 (0.94)	564 (1240)
1100 (44)	–	–
1200 (48)	0.90 (1.18)	633 (1392)

SERVICE CAPACITIES

	litres	UK gal
Fuel tank	240	53
Engine coolant	25.5	5.6
Engine oil	19.5	4.0
Swing reduction gear	2.2	0.5
Hydraulic system	124	27.3
Hydraulic tank	73	16.0
Transmission	3.4	0.7
Axle differentials (each)	Rear 12, Front 14	Rear 2.6, Front 3
Axle hubs (each)	2.0	0.5

STANDARD EQUIPMENT

Auto engine warm up; Double element air cleaner; Radiator fine mesh grille; Heavy duty alternator; Electrics isolator; Heavy duty batteries; Tinted safety glass; Radio & cassette player; Operators storage box; Removable floor mat; Windscreen wash/wipe; Plug-in power socket; Power boost; Auto-idle; One-touch engine speed control; Hydraulic cushion control; Nephron hydraulic oil filtration; Grouped HSP pressure test points; Auxiliary pipework mounting brackets; Work lights – boom & mainframe mounted; Upper structure under covers; External mirrors; Handrail & nonslip pads; Creep speed; Tipping link with stowage lock; Load holding valves (lift); On the move gear change; Oscillating axle lock; Adjustable steer column; Spring assisted opening screen; Auto engine/hydraulics warm up.

OPTIONAL EQUIPMENT

Hose burst check valves & Overload warning system; Tipping link mounted lift points; General purpose buckets; Ditch/grading buckets; Quickhitch buckets; Hydraulic hammers; Hammer pipework; Low flow (grab rotate/weedcutter) pipework; Bucket to grab changeover pipework; Air conditioning; Cab mounted & rear work lights; Rotating beacon; Opening roof window; Additional toolbox; Grab stowage bar.

OPERATING WEIGHTS

Chassis					
	15610kg (34415lb)	16050kg (35385lb)	16490kg (36355lb)	17030kg (37545lb)	17370kg (38295lb)
	16210kg (35735lb)	16650kg (36705lb)	17090kg (37675lb)	17630kg (38865lb)	17970kg (39615lb)

Machine equipped with excavating bucket and dual wheels. For single wheels subtract 400kg (880lb).



JCB WHEELED EXCAVATOR | JS175W



WORKING RANGES

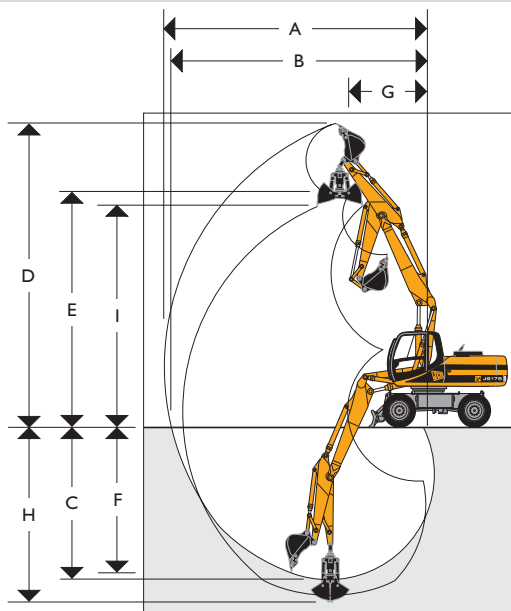

WORKING RANGES

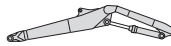
Boom							
	2.25m	2.70m	3.05m	2.25m	2.70m	3.05m	
Dipper arm							
A Max digging reach	mm (ft-in)	8655 (28-4)	9075 (29-8)	9455 (31-0)	8600 (28-2)	9025 (29-7)	9350 (30-7)
B Max digging reach (on ground)	mm (ft-in)	8455 (27-9)	8875 (30-0)	9275 (30-5)	8400 (27-6)	8850 (29-1)	9195 (30-1)
C Max digging depth	mm (ft-in)	5425 (17-9)	5875 (19-3)	6225 (20-5)	5300 (17-4)	5750 (18-9)	6100 (20-0)
D Max digging height	mm (ft-in)	9195 (30-2)	9625 (31-6)	10025 (32-9)	9700 (31-8)	10000 (32-9)	10235 (33-6)
E Max loadover height	mm (ft-in)	6405 (21-0)	6775 (22-3)	7145 (23-5)	7000 (23-0)	7325 (24-0)	7575 (24-9)
F Max vertical wall cut depth	mm (ft-in)	4490 (14-8)	5050 (16-6)	5610 (18-5)	4450 (14-7)	4900 (16-1)	5250 (17-2)
G Min swing radius	mm (ft-in)	3000 (9-10)	3000 (9-10)	3000 (9-10)	2725 (9-0)	2675 (8-8)	2635 (8-7)
H Max digging depth with grab	mm (ft-in)	5835 (19-1)	6285 (20-7)	6635 (21-8)	5710 (18-9)	6160 (20-3)	6510 (21-4)
I Max dumping height with grab	mm (ft-in)	5995 (19-8)	6365 (20-9)	6735 (22-1)	6590 (21-7)	6915 (22-7)	7165 (23-6)
Bucket rotation		183°	183°	183°	183°	183°	183°
Dipper tearout	kgf (lbf)	10128 (22330)	8440 (18608)	7470 (16470)	9035 (19920)	7530 (16600)	6665 (14690)
Dipper tearout with boost	kgf (lbf)	10990 (24230)	9160 (20196)	8100 (17860)	9600 (21165)	8100 (17860)	7235 (15950)
Bucket tearout	kgf (lbf)	10400 (22930)	10400 (22930)	10400 (22930)	10400 (22930)	10400 (22930)	10400 (22930)
Bucket tearout with boost	kgf (lbf)	10740 (23680)	10740 (23680)	10740 (23680)	10740 (23680)	10740 (23680)	10740 (23680)



JCB WHEELED EXCAVATOR | JS175W



MONOBOOM LIFT CAPACITIES

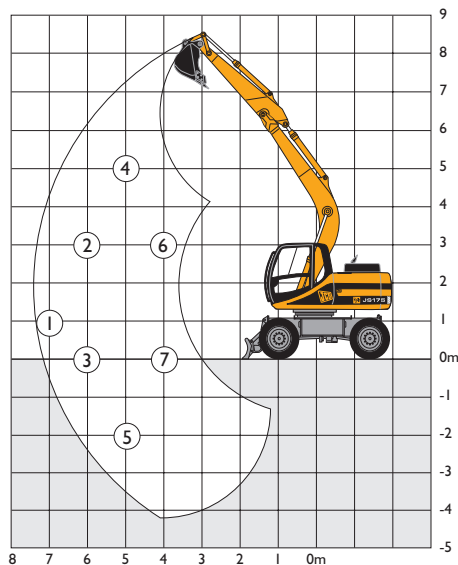

Bucket weight 564kg

O/E = Lift capacity over least stable end. 360° = Lift capacity full circle.

- Notes:
- Lifting capacities are based on the ISO standard, that is: 75% of minimum tipping load or 87% of hydraulic lift capacity, whichever is the less. Lifting capacities marked * are based on hydraulic capacity.
 - Lift capacities assume that the machine is on firm, level ground, stabilized and equipped with twin tyres, an approved lifting point and bucket.
 - Lift capacities may be limited by local regulations. Please refer to your dealer.

MONOBOOM LIFT CAPACITIES

Chassis														
		2.25m	2.70m	3.05m	2.25m	2.70m	3.05m	2.25m	2.70m	3.05m	2.25m	2.70m	3.05m	
Dipper arm	①	O/E	2835	2850	2830	2935	2950	2930	3915	3935	3915	4040	4060	4040
	360°	1675	1685	1665	2030	2045	2020	2625	2640	2615	3050	3065	3040	
②	O/E	3840	3900	3905	3965	4020	4025	5250	5315	5325	5405	5470	5480	
	360°	2355	2410	2410	2805	2860	2860	3560	3615	3620	4105	4165	4170	
③	O/E	3555	3565	3550	3680	3685	3675	4945	4955	4945	5100	5110	5100	
	360°	2100	2100	2085	2535	2545	2530	3280	3290	3275	3820	3825	3815	
④	O/E	5575	5685	—	5730	5845	—	7585	7710	—	7790	7915	—	
	360°	3520	3620	—	4125	4230	—	5165	5276	—	5925	6040	—	
⑤	O/E	4705	4665	4635	4865	4820	4795	6635	6590	6565	6840	6795	6770	
	360°	2750	2710	2680	3330	3285	3260	4325	4280	4250	5050	5010	4980	
⑥	O/E	7565	7735	7850	7785	7960	8075	10755	10955	11090	11050	11250	11385	
	360°	4520	4465	4755	5385	5535	5635	6920	7085	7195	8075	8245	8365	
⑦	O/E	6830	6830	6875	7055	7050	7095	9925	9925	9980	10220	10220	10275	
	360°	3895	3890	3920	4730	4725	4760	6215	6215	6255	7335	7332	7375	

Unit: kg



JCB WHEELED EXCAVATOR | JS175W



TRIPLE ARTICULATION LIFT CAPACITIES

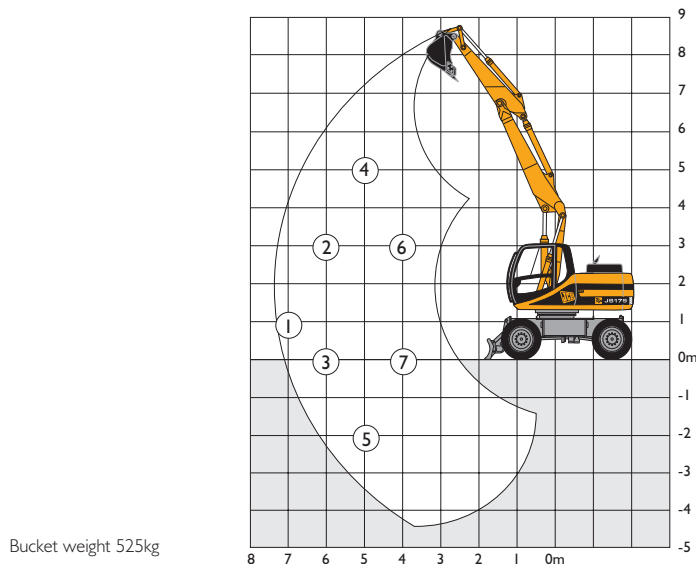

O/E = Lift capacity over least stable end. 360° = Lift capacity full circle.

- Notes:
1. Lifting capacities are based on the ISO standard, that is: 75% of minimum tipping load or 87% of hydraulic lift capacity, whichever is the less. Lifting capacities marked * are based on hydraulic capacity.
 2. Lift capacities assume that the machine is on firm, level ground, stabilized and equipped with twin tyres, an approved lifting point and bucket.
 3. Lift capacities may be limited by local regulations. Please refer to your dealer.

TRIPLE ARTICULATION LIFT CAPACITIES

Chassis														
		2.25m	2.70m	3.05m	2.25m	2.70m	3.05m	2.25m	2.70m	3.05m	2.25m	2.70m	3.05m	
Dipper arm	①	O/E	2735	2760	2745	2835	2860	2845	3670*	3615*	3510*	3670*	3615*	3510*
	360°	1540	1565	1545	1905	1930	1915	2515	2540	2525	2950	2975	2960	
②	O/E	3785	3755*	3565*	3905	3755*	3565*	3940*	3755*	3565*	3940*	3755*	3565*	
	360°	2125	2330	2345	2715	2790	2810	3490	3570	3565*	3940*	3755*	3565*	
③	O/E	3425	3440	3433	3550	3565	3555	4395*	4360*	4290*	4395*	4360*	4290*	
	360°	1930	1940	1930	2380	2395	2385	3140	3155	3150	3690	3705	3700	
④	O/E	3835*	3535*	3245*	3835*	3535*	3245*	3835*	3535*	3245*	3835*	3535*	3245*	
	360°	3505	3535*	3245*	3835*	3535*	3245*	3835*	3535*	3245*	3835*	3535*	3245*	
⑤	O/E	4530	4480	4450	4690	4640	4610	4890*	5085*	5170*	4890*	5085*	5170*	
	360°	2530	2485	2455	3120	3075	3045	4135	4090	4055	4865	4830	4800	
⑥	O/E	5880*	5440*	5065*	5880*	5440*	5065*	5880*	5440*	5065*	5880*	5440*	5065*	
	360°	4445	4640	4765	5330	5430	5065*	5880*	5440*	5065	5880*	5440*	5065*	
⑦	O/E	6570	6585	6650	6790	6810	6870	6965*	6950*	6905*	6965*	6950*	6905*	
	360°	3590	3605	3650	4440	4450	4500	5945	5960	6020	6965*	6950*	6905*	

Unit: kg



A GLOBAL COMMITMENT TO QUALITY

JCB's total commitment to its products and customers has helped it grow from a one-man business into Britain's largest privately owned manufacturer of backhoe loaders, crawler excavators, wheeled excavators, telescopic handlers, wheeled loaders, dump trucks, rough terrain fork lifts, industrial fork lifts, mini/midi excavators, skid steer loaders and tractors.

By making constant and massive investments in the latest production technology, the JCB factories have become some of the most advanced in Europe.

By leading the field in innovative research and design, extensive testing and stringent quality control, JCB machines have become renowned all over the world for performance, value and reliability.

And with a global sales and service network of over 400 distributors and agents, the company exports over 70% of its production to all five continents.

Through setting the standards by which others are judged, JCB has become one of Britain's most impressive success stories.

